

# INTCO INTRODUCTION



# 1

## Factory Tour



Shandong Factory I

PS Extrusion and Assembling



Shandong Factory II

PP, CANVAS



Shanghai Intco

PS Extrusion



Zhenjiang Intco

Machinery Manufacturing



Lu'an Intco

PS Extrusion



Malaysia Intco

PS Pelletizing



# 1 Capacity Scale



131 Moulding Extruder Lines + 7 Wrapping Lines

138



51  
Assembly Lines

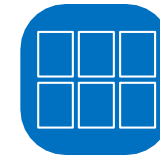

8,000  
Containers/Year



2,300  
Employees

1

# Intco Advantage- Variety of products



Photo Frame



Art Frame



Mirror



3D Art



Functional Board



Acrylic Printing



Canvas



Frame Mouldings



# Intco Advantage- Variety of products



### PS 3D Wall Panel



JC963-E-23  
Size: 240 x 12.2 x 1.2cm



### PS Outdoor Flooring



### PS Chair-Mouldings

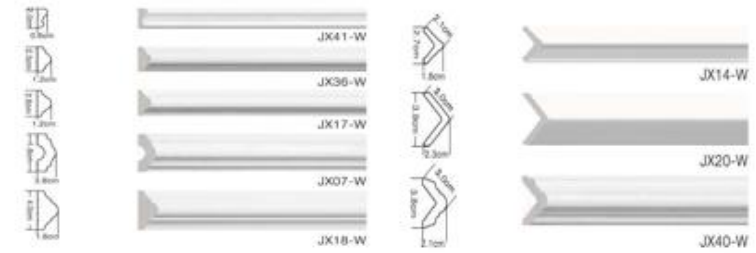
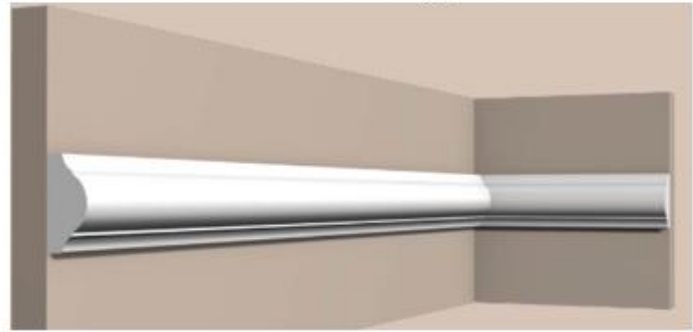

### PS Skirting Board

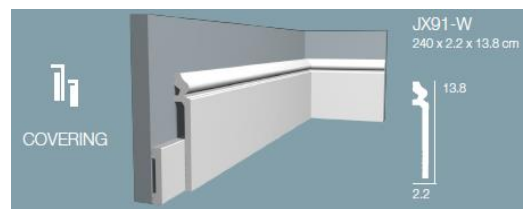

### PS Ceiling Board

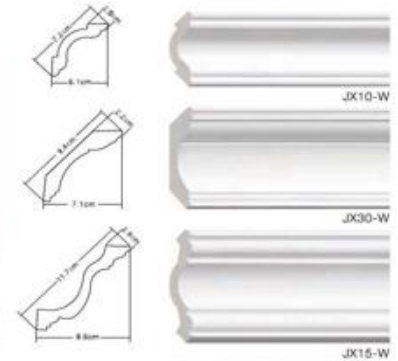
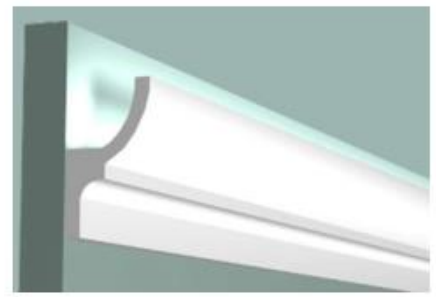

# Qualification & Certificates



No Formaldehyde



Anti UV



No Heavy Metal



Impact Modified HIPS Performance



Resistance



Anti-aging



Fire Retardant



Lead Content

2

# INTCO PS PRODUCTS



# 2

## Gallery Frame





# 2

## Photo Frame with Art Paper



# 2

## Frame With Clip



# 2

## Door Mirror



### Moulding:





# Door Mirror

DUNNES STORES



# 2

## Standing Mirror



# 2

## Mirror Sets

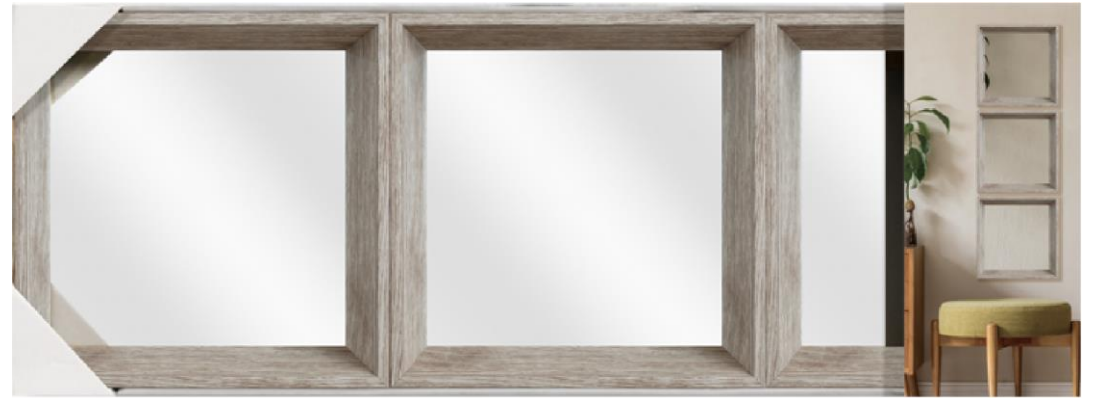



# 2

## Wall Mirror



# 2

## Wall Mirror



# 2

## Wall Mirror

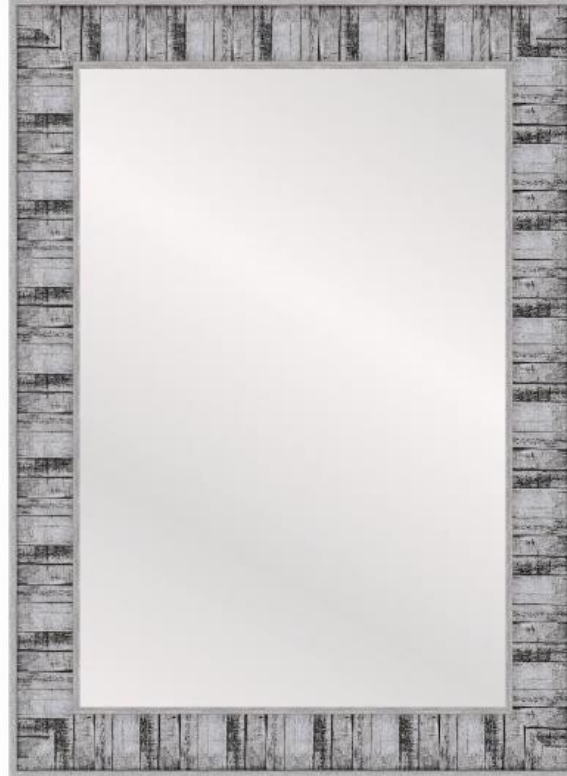



# 4

## Memo Board

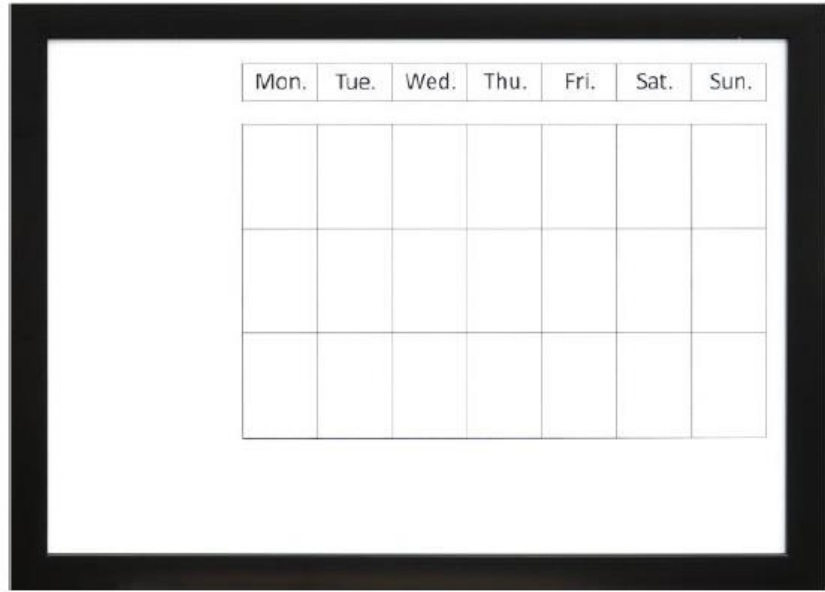

# 4

## Art Frame

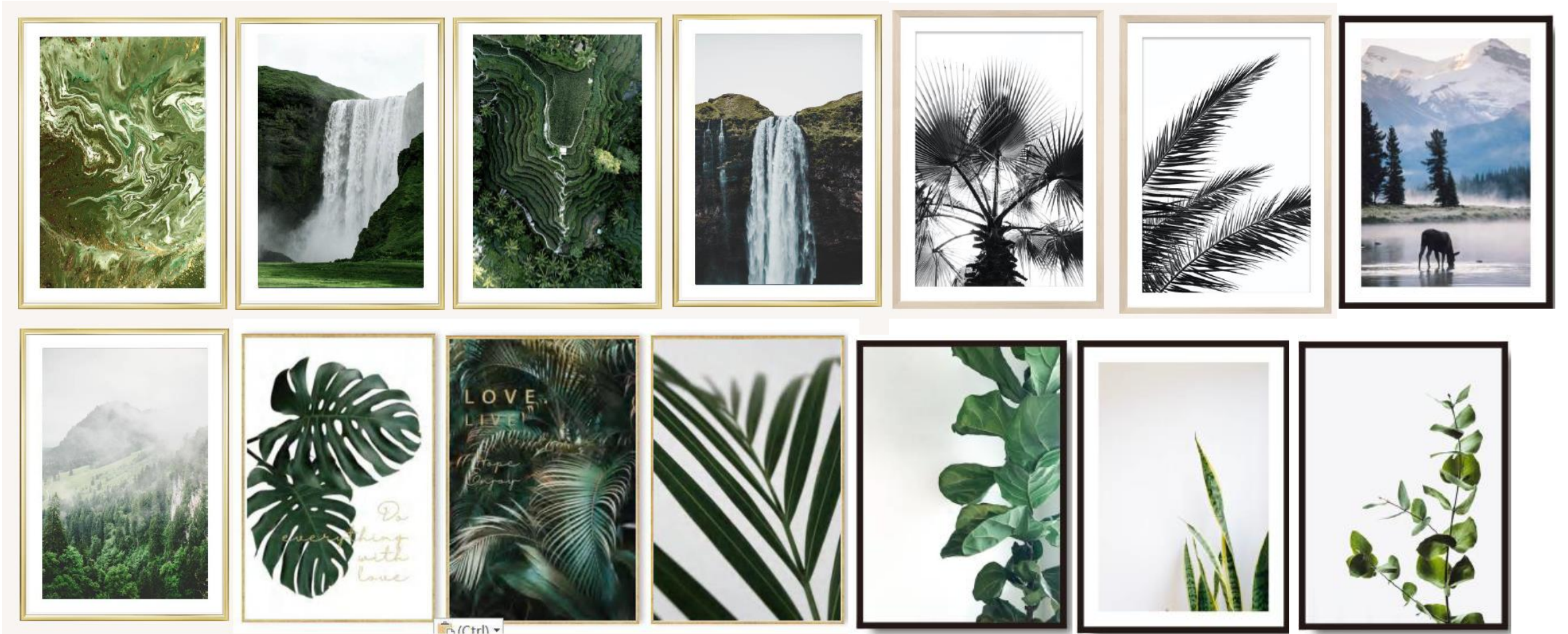



# 4

## Art Frame— Abstract design

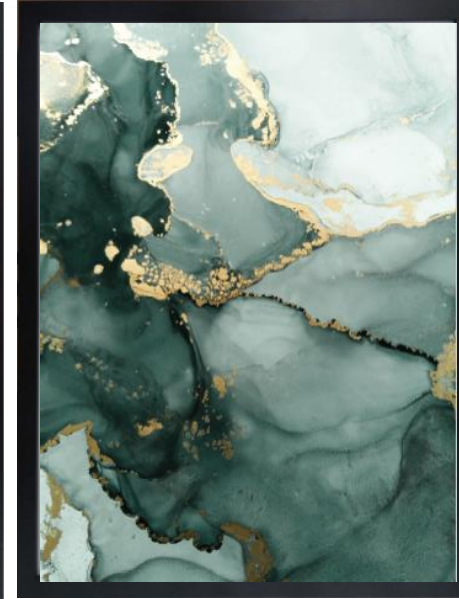
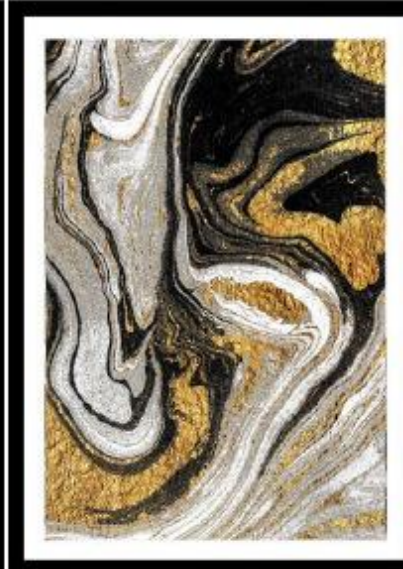



# 2

## Wall panel



# 2

# Skirting Board





# Ceiling Moulding

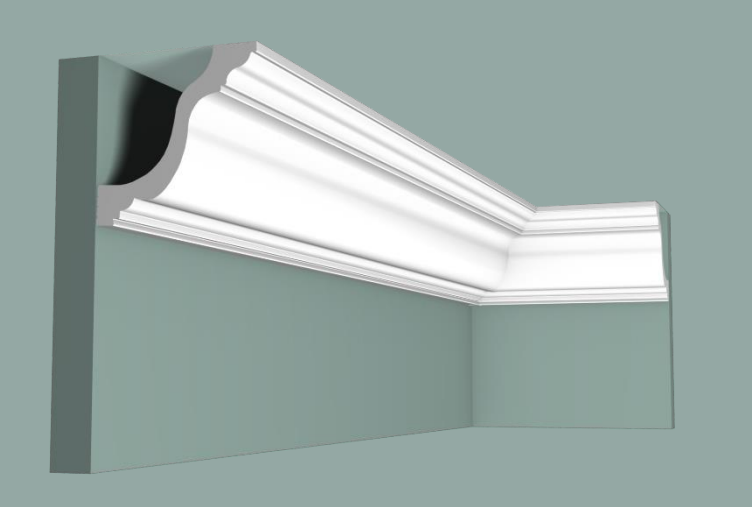



# Chair-rail Moulding

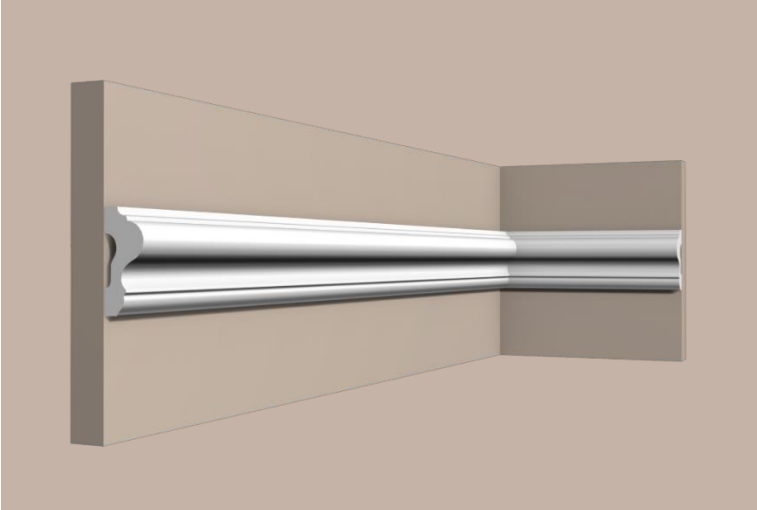

# Door and Window Frame Moulding





# Outdoor Furniture & Flooring Moulding



Outdoor Fence

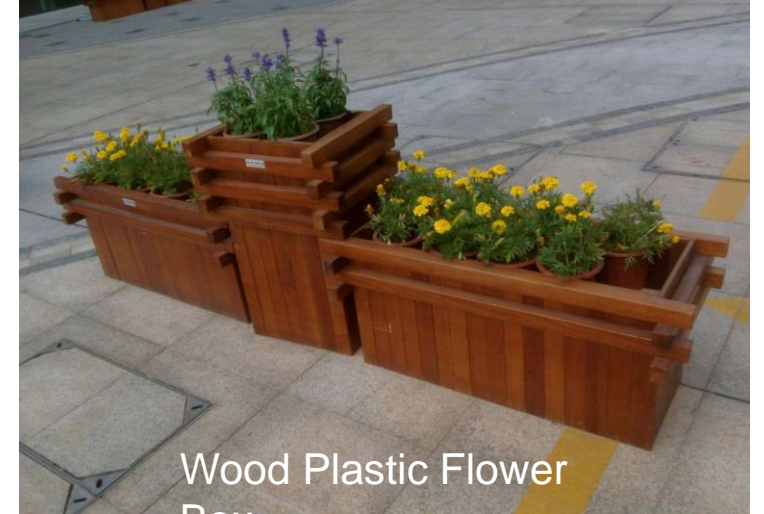

Wood Plastic Flower Box



Outdoor Furniture



Trash Bin



Exterior Wall Decoration







THANKS